

SPECIFICATION OF THERMOELECTRIC COOLING ASSEMBLY 180-24-AA

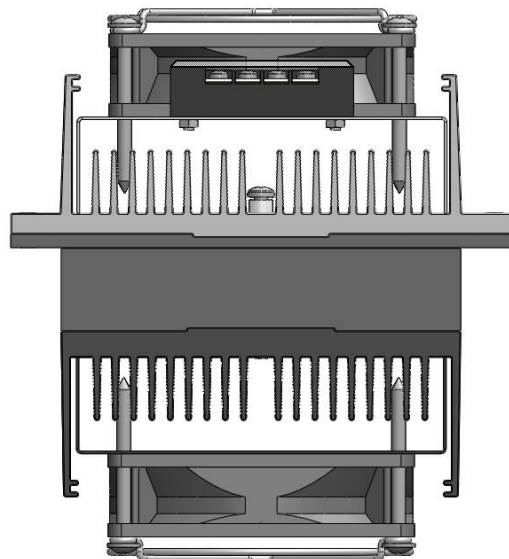

<i>Thermoelectric parameters</i>	<i>Unit</i>	<i>Value</i>
Operating voltage (U)	Volts	24
Operating current (I)	Amps	5.8
Electric power (P)	Watts	139
Operating cooling power (Qc)	Watts	110
Max. cooling power	Watts	125
Tolerance	%	±10

<i>Operation parameters</i>	<i>Unit</i>	<i>Value</i>
Working temperature range	°C	-30 ÷ +70
Net weight	kg	3.7

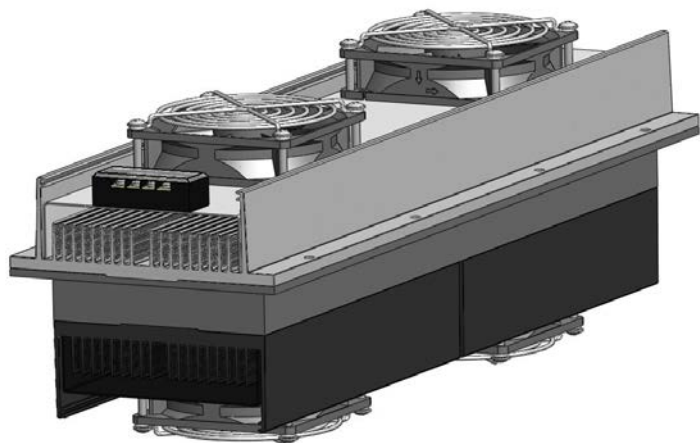
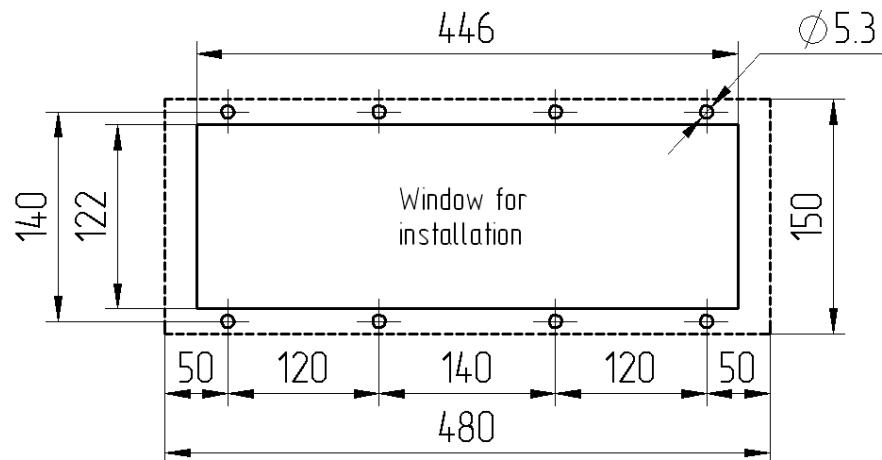
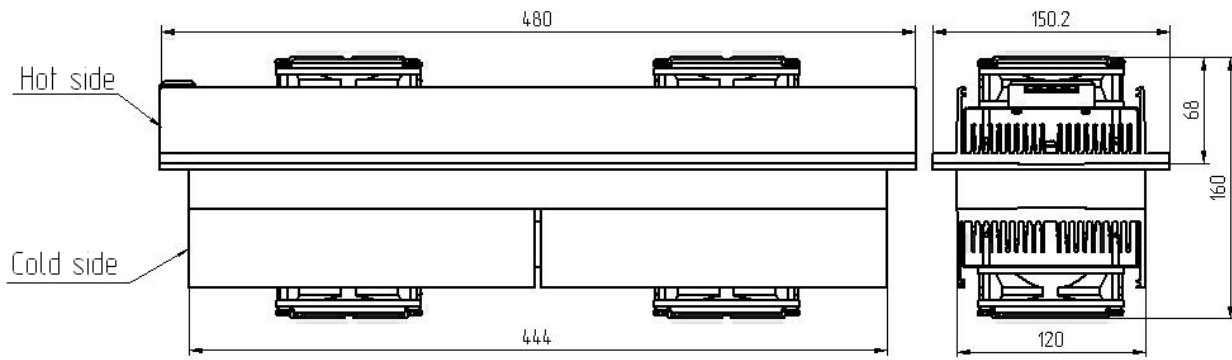

Q_c , Watts

